

Blusafe Breeze Smart Handle

Fitting Instructions & User Setup

v2023.1

Model B



Do you know we offer
professiona installation
service?
Please scan the QR to find
your local installer



Dear User,

Thank you for purchasing the Blusafe Breeze smart handle. This manual will help you both install and set up the fingerprint smart handle.

Follow the setup instructions on page 6 to add fingerprints to your handle.

Why not watch the installation and setup video?

Simply:

- Search '**Blusafe Breeze Installation**' on Youtube
- Follow this link:
https://www.youtube.com/channel/UC_NJFuQFKW976isCClpN8cw
- Scan this QR code:



Breeze Model B Smart Handle

Package Contents

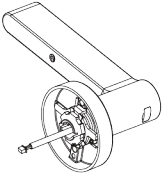

A-External handle
x 1

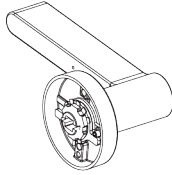

B-Internal handle
x 1



E-Handle
mounting plate
x 2

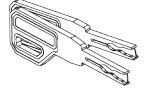

F-Key
x 2

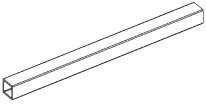

G-Hollow spindle
x 1

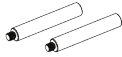

H-Connection boss
x 2



I-Split bolt
x 2



K-Setting needle
x 1

Changing the Handle Direction

Locate the external handle (A), and hold it up to the external side of the door. Check that the handle opens in the right direction. If it doesn't you will need to change the handle direction. If this needs changing, it's likely that the internal one will too. Please follow the following instructions or watch the video on our YouTube channel.

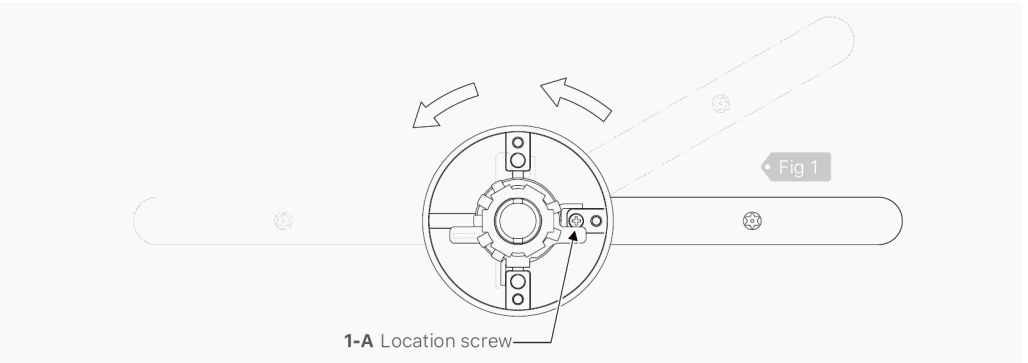

- a** Look at the inside face of the handle, you will see a small location screw (see Fig.1). Push the handle down slightly to relieve pressure and remove this location screw.
- b** Rotate the handle 180 degrees so that it's pointing the other way. Ensure the spring arm doesn't jump over the pillar that holds the location screw (see the spring ends in Fig. 2 and 3).
- c** Pull the handle down slightly in its new position to relieve pressure and replace the location screw back into its position. (You should start with either Fig. 2 or 3, then end up with the other one).
- d** Repeat on the other handle.
- e** Check that both handles now work in the correct direction for your door.

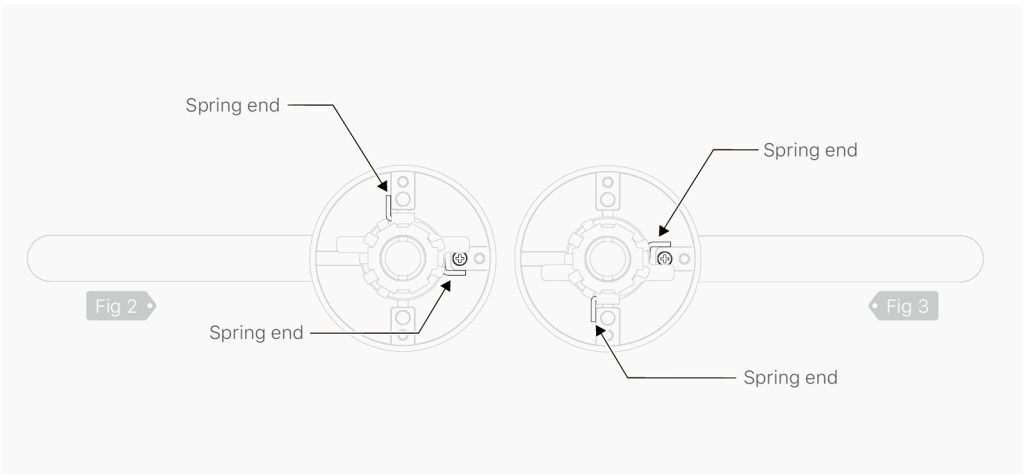

Model B Installation

- 01** Please check whether the holes on your door matches the Breeze mounting holes. If not, locate the hollow spindle (G) and the paper fitting template. Follow the instructions on the template to ensure it lines up correctly. You can then use the template to mark the door with a pen/pencil where holes need to be drilled. Do this on both sides of the door.
- 02** Please make sure the handles open in the correct direction. If not, go back and follow the "Change the Handle Direction" instructions to make sure they open correctly before moving to the next step.
- 03** With the external handle (A) in hand, take the connection bosses (H) and screw them into the positions at the left and right sides of the inside face.
- 04** Take the spindle (G) and feed the wire through the hollow opening, then push the spindle into the handle. Push the mounting plate (E) over the spindle and connection bosses until it's flush with the handle.

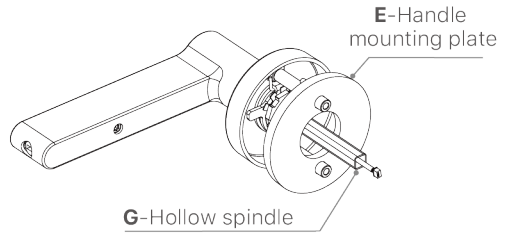
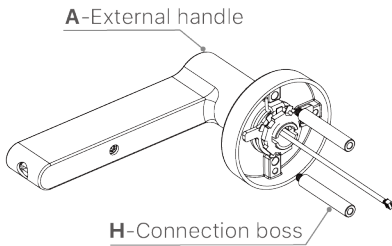

- 05** Feed the spindle through the latch in the door and the connection bosses through the holes in the latch. The handle should push flat against the door.
- 06** Place the internal handle (B) and the setting needle (K). At the back of the handle grip, there is a small hole. Push the setting tool into this hole and press hard until the magnetic handle cover (B-1) pops off. remove the cover and also the battery cassette (B-2)

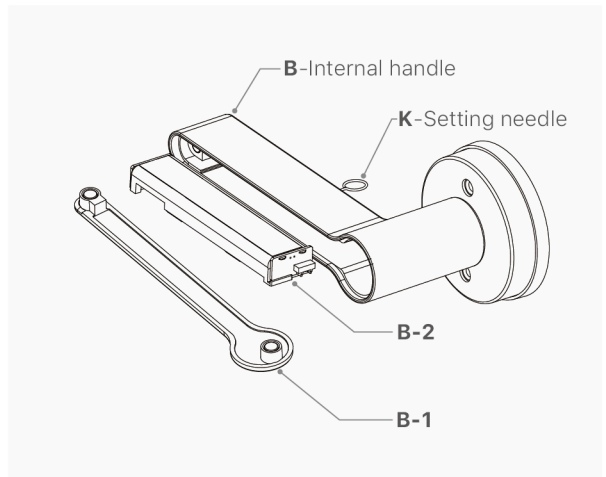
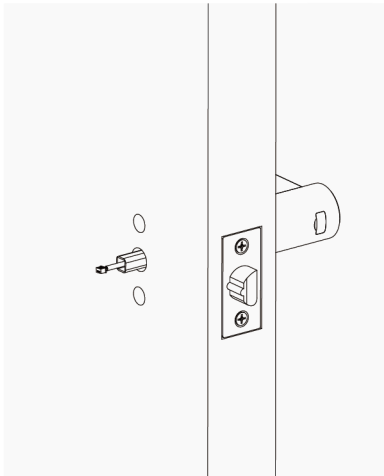

- 07** Take the second mounting plate (E) and place it over the spindle. holding the internal handle (B), feed the wire and spindle through the spindle hole in the handle. You will be able to see the cable coming through from the back of the handle. use the screws provided (I) and fix the internal handle to the external handle through the holes.

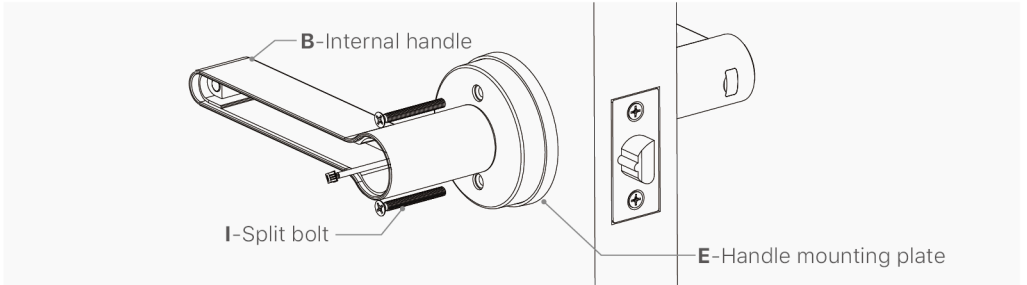

- 08** Insert 4 AAA batteries into the battery cassette (B-2). connect the battery cassette (B-2) to the wire (you will hear a beep). Then insert the battery cassette into the handle, ensuring that the side containing the cable connector and setting button goes in first.

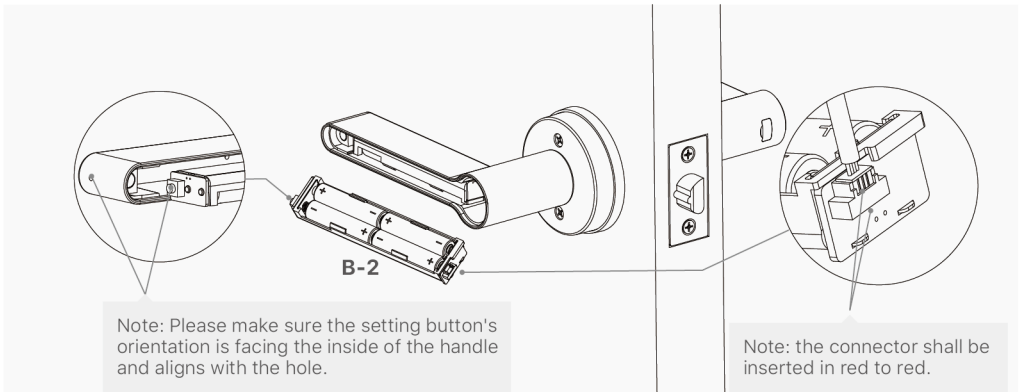

- 09** Test the handle. Push the internal handle down, it should operate the latch fully. then touch the fingerprint sensor on the external handle, it should light up GREEN and you should hear the mechanism turn. push the handle down and it should operate the latch.
- After ensuring that everything is working correctly, put the magnetic handle cover (B-1) back onto the handle.

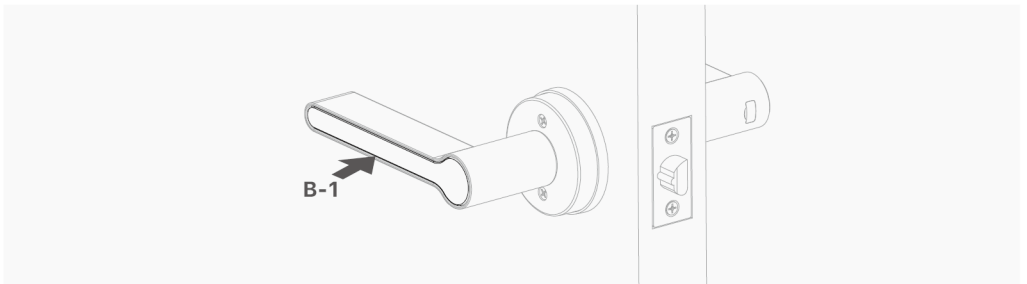

Breeze Smart Handle

User Setup

Please read carefully before setup

Important !

Upon initial use of the Breeze Smart Handle and after a reset, the handle can be opened by any fingerprint.

The fingerprint sensor and finger that touches the sensor should always be kept clean, dry and free from grease.

The fingerprints will remain stored when the battery runs low and when the battery is changed.

When adding fingerprints, if no further operation is detected within 12 seconds after each previous operation, the system will automatically log out.

It is recommended to use this product in an environment where it will not be exposed to heavy rain, salt water, or direct sunshine, which could damage the internal electronics.

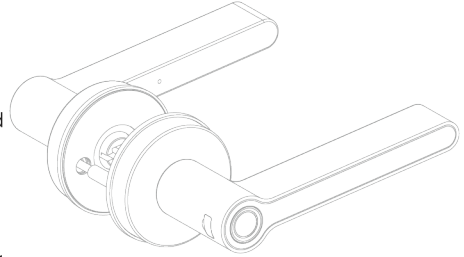

Low Battery Indication

When the battery is running low, you will hear a long triple beep when operating the handle. The handle can be operated approximately 200 times after this warning. After that, the batteries must be changed.



It is recommended to change the batteries after the first few low battery warnings.

Input / Change the Batteries

It requires 4x AAA alkaline batteries to power the handle.

The batteries will power the handle for 6-8 months depending on the usage and environment. It is recommended to change the batteries every 6 months for optimal performance.

To change the batteries, insert the setting needle provided into the release hole (located in the middle at the back of the internal handle grip), then push hard and the magnetic handle cover will come off.

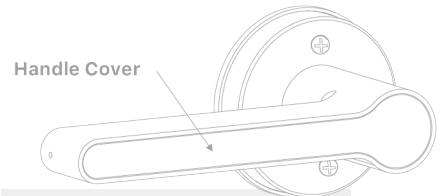
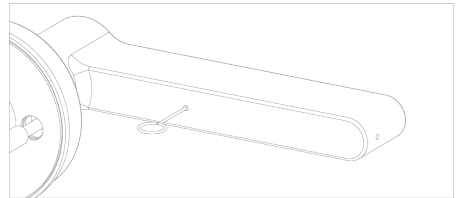

Note: Please keep the setting needle safe as it is used to set many functions on the handle. If you lose this, it is possible to use a paperclip to push the set button.

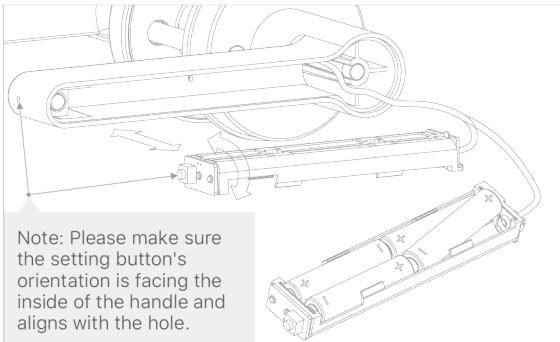

Note: Please make sure the setting button's orientation is facing the inside of the handle and aligns with the hole.

Pull out the battery cassette and change the batteries. Put the battery cassette back into its original position (see diagram) and ensure the cable is still connected. Put the handle cover B-1 back on.

Emergency Power Supply

If the handle runs out of battery, you can use a mobile power pack to power the handle.

Open the rubber charging cover next to the fingerprint sensor on the external handle. Insert a Micro-USB cable into the handle and charge using a mobile power bank or USB mains device.

The handle also has a backup key that can be used in this scenario.



Fingerprint Registration

2. How to set up ADMIN Fingerprints

The FIRST 3 fingerprints registered will become ADMIN fingerprints. The ADMIN fingerprints are required to authorise adding any new fingerprints, or erasing fingerprint data. Please ensure the ADMIN fingerprints belong to the main user or trusted users.

- 2a** To set up the first ADMIN fingerprint, use the setting needle (K) to press the set button. The set button is located at the end of the internal handle (see diagram).
- 2b** Press the button once, 1 beep will sound and the LED lights up GREEN. You will hear another long beep, and LED lights then turn BLUE.
- 2c** To add your desired first ADMIN fingerprint, briefly place your finger/thumb on the sensor and then REMOVE it when you hear a double beep (touch and remove), repeat this 3 more times until the LED turns GREEN and you hear a beep. (When adding fingerprints it is recommended that you press your finger/thumb in different positions so that the fingerprint data is fully collected). Your first ADMIN fingerprint is now registered. The LED will turn BLUE and stay on for about 30 seconds then turn off.

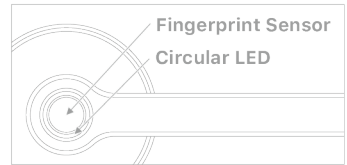
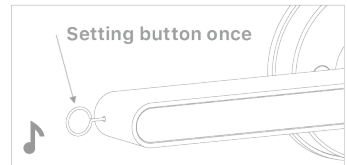

Note: If you want to continue setting the second and third ADMIN fingerprints straight after the first one, repeat step 2c when the LED remains BLUE. If you want to set up the second and third ADMIN fingerprints at a different time, wait till the LED turns off and then follow step 2d below.

- 2d** To set up the 2nd and 3rd ADMIN fingerprints, repeat this process from step 2a. Now press the button once, 3 beeps will sound and the LED turns BLUE. Press the sensor with an ADMIN fingerprint (You need to use the 1st or 2nd ADMIN fingerprint to authorise adding the 2nd or 3rd), you will hear a long beep and the LED lights will turn GREEN then turn BLUE. Follow the process in 2c again.

Note 1: You do not need to add all 3 ADMIN fingerprints at once, however keep in mind that the first 3 registered prints will all be ADMIN users (If you wish to be the only ADMIN user, register the first 3 fingerprints as your own).

Note 2: You can verify the success of registration by putting the registered fingerprint onto the sensor, after the LED turns off, to see if it will trigger the handle to unlock.

Add USER Fingerprints

3. How to set up USER Fingerprints

Note that an ADMIN fingerprint will be required to authorise the registration of new fingerprints on the handle.

We recommend that all users register at least 3 fingerprints to ensure that they have a backup if one doesn't recognise.

- 3a** Use the setting needle (K) to press the set button. The set button is located at the end of the internal handle (see diagram). Press the button once, 1 beep will sound and the LED lights up BLUE.
- 3b** Press the fingerprint sensor with a registered ADMIN fingerprint, you will hear a long beep and the LED will flicker GREEN, then turn BLUE. USER registration is now ready.

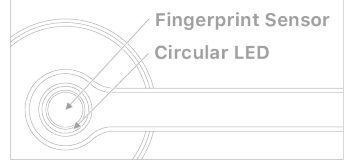
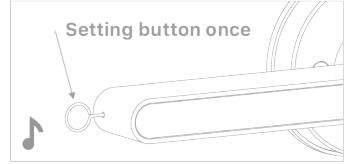

Note: if 1 triple beep sounds and the LED turns off, the authorisation was unsuccessful. Repeat step 3a.

- 3c** To add your desired USER fingerprint, briefly place your finger/thumb on the sensor and then REMOVE it when you hear a double beep (touch and remove), repeat this 3 more times until the LED turns GREEN. (When adding fingerprints, it is recommended that you press your finger/thumb in different positions so that the fingerprint data is fully collected).



Your USER fingerprint is now registered.

Note: A total of 3 ADMIN and 47 USER fingerprints can be registered. Once all fingerprints are registered, 1 triple beep will sound and the LED will turn off indicating that the USER capacity is full.

Unlock the Handle with the Fingerprint

Press and hold your registered finger/thumb on the fingerprint sensor. You only need to press your finger lightly and do not need to push hard. Remember to press your finger in the position you registered it in.

If a beep sounds and the LED lights up GREEN, the fingerprint is valid. Wait until the mechanism turns, push the handle down and open.

If a triple beep sounds and the LED lights up RED, validation has failed. Press the fingerprint again with a registered fingerprint. If you have registered multiple fingers as suggested, try another finger.

5 invalid attempts within 5 minutes will cause a system lock down for 90 seconds. The handle will not respond during system lock down. The lock down can be cleared by pressing the set button and giving ADMIN validation or overridden by using the key.

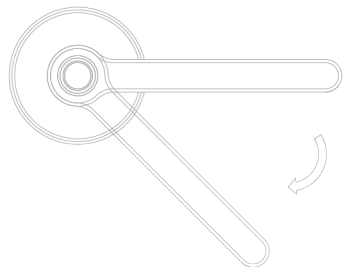
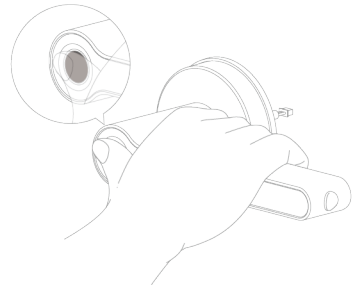

Unlock the Handle with the Key

The handle also comes with 2 mechanical keys. You can use the key to unlock the door at any point, also when the handle has no power and it is in lock down.

Insert the key into the end of the external handle and turn (see diagram). Push the handle down and open the door.

If you would like to leave the door unlocked and ensure it doesn't lock upon every close, simply leave the key turned in the handle. The handle will now operate like any other door handle.

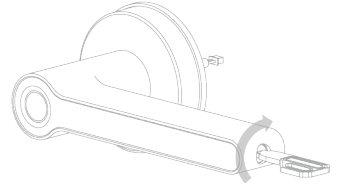

Deleting All Fingerprints (Reset)

4a Using the setting needle provided, press and hold the set button for 8 seconds (located in the end of the internal handle), until you hear a double beep and the LED lights up BLUE. Release the set button.

4b Press the fingerprint sensor with a registered ADMIN fingerprint, if successful you will hear a long beep and the LED will light up GREEN (If the LED lights up RED, an ADMIN fingerprint hasn't been recognised, please try an ADMIN fingerprint again).

All fingerprint data has been deleted and the handle has been reset.

4c When the handle has been reset and there is no data saved, any fingerprint can be used to unlock the handle.

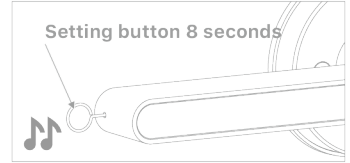

Notes

5 invalid attempts within 5 minutes will cause a system lock down for 90 seconds. The handle will not respond during system lockdown. The lock down can be cleared by pressing the set button and giving ADMIN validation or overridden by using the key.

When adding fingerprints, if no further operation is detected within 12 seconds after each previous operation, the system will automatically log out.

When registering fingerprints, it is recommend that you press your finger on the sensor in different positions so that the fingerprint data is fully collected.

Product Specification

Power	4 x AAA Batteries
Battery Life	Up to 200 days
Spatial Resolution	508dpi
Fingerprint Capacity	50 fingerprints (3 x admins + 47 x users)
Mechanical Key	2 keys
IP Rating	IP60
Operating Temperature	-10°C~60°C
Humidity	20% ~ 93%RH

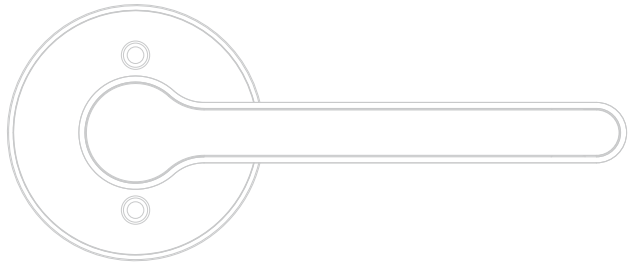

Please scan the QR to
get the newest manuals
on Blusafe products



Find out more about
Blusafe vulnerability
discovery & disclosure
procedures